



S9j Server Installation Guide

Document Version 0.1

Aug 2018

© Copyright Bitmain Technologies Holding Company 2007 – 2022. All rights reserved.

Bitmain Cayman (hereinafter referred to as 'Bitmain') reserves the right to make corrections, modifications, enhancements, improvements, and other changes to its products and services at any time and to discontinue any product or service without notice.

Customers should obtain the latest relevant information before placing orders and should verify that such information is current and complete. All products are sold subject to Bitmain's terms and conditions of sale supplied at the time of order acknowledgment.

Bitmain warrants performance of its products to the specifications applicable at the time of sale in accordance with Bitmain's standard warranty. Testing and other quality control techniques are used to the extent Bitmain deems necessary to support this warranty. Except where mandated by government requirements, testing of all parameters of each product is not necessarily performed.

Bitmain assumes no liability for third-party applications assistance. Customers are responsible for their products and applications using Bitmain components. To minimize the risks associated with customer products and applications, customers should provide adequate design and operating safeguards.

Bitmain does not warrant or represent that any license, either express or implied, is granted under any Bitmain patent right, copyright or other Bitmain intellectual property right relating to any combination, machine, or process in which Bitmain products or services are used. Information published by Bitmain regarding third-party products or services does not constitute a license from Bitmain to use such products or services or a warranty or endorsement thereof. Use of such information may require a license from a third party under the patents or other intellectual property of the third party, or a license from Bitmain under the patents or other intellectual property of Bitmain.

Resale of Bitmain products or services with statements different from or beyond the parameters stated by Bitmain for that product or service voids all express and any implied warranties for the associated Bitmain product or service and is an unfair and deceptive business practice. Bitmain is not responsible or liable for any such statements.

All company and brand products and service names are trademarks or registered trademarks of their respective holders.

All text and figures included in this publication are the exclusive property of Bitmain, and may not be copied, reproduced, or used in any way without the express written permission of Bitmain. Information in this document is subject to change without notice and does not represent a commitment on the part of Bitmain. Although the information in this document has been carefully reviewed, Bitmain does not warrant it to be free of errors or omissions. Bitmain reserves the right to make corrections, updates, revisions or changes to the information in this document.

Bitmain
Tel:+86-400-890-8855
www.bitmain.com

Table of Contents

1. Overview	4
1.1 S9j Server Components	5
1.2 Specifications	6
2. Connecting the Power Supply	7
3. Setting Up the Server	8
4. Configuring the Server	10
5. Monitoring Your Server	11
6. Administering Your Server	12
6.1 Checking Your Firmware Version	12
6.2 Upgrading Your System	12
6.3 Modifying Your Pass Word	13
6.4 Restoring initial Settings	13

1. Overview

The S9j server is one of the products in Bitmain's S9 server series. All S9j servers are tested and configured prior to shipping to ensure easy set up.



You must provide your own ATX power supply.

1.1 S9j Server Components

The S9j server main components and controller front panel are shown in the following figure:

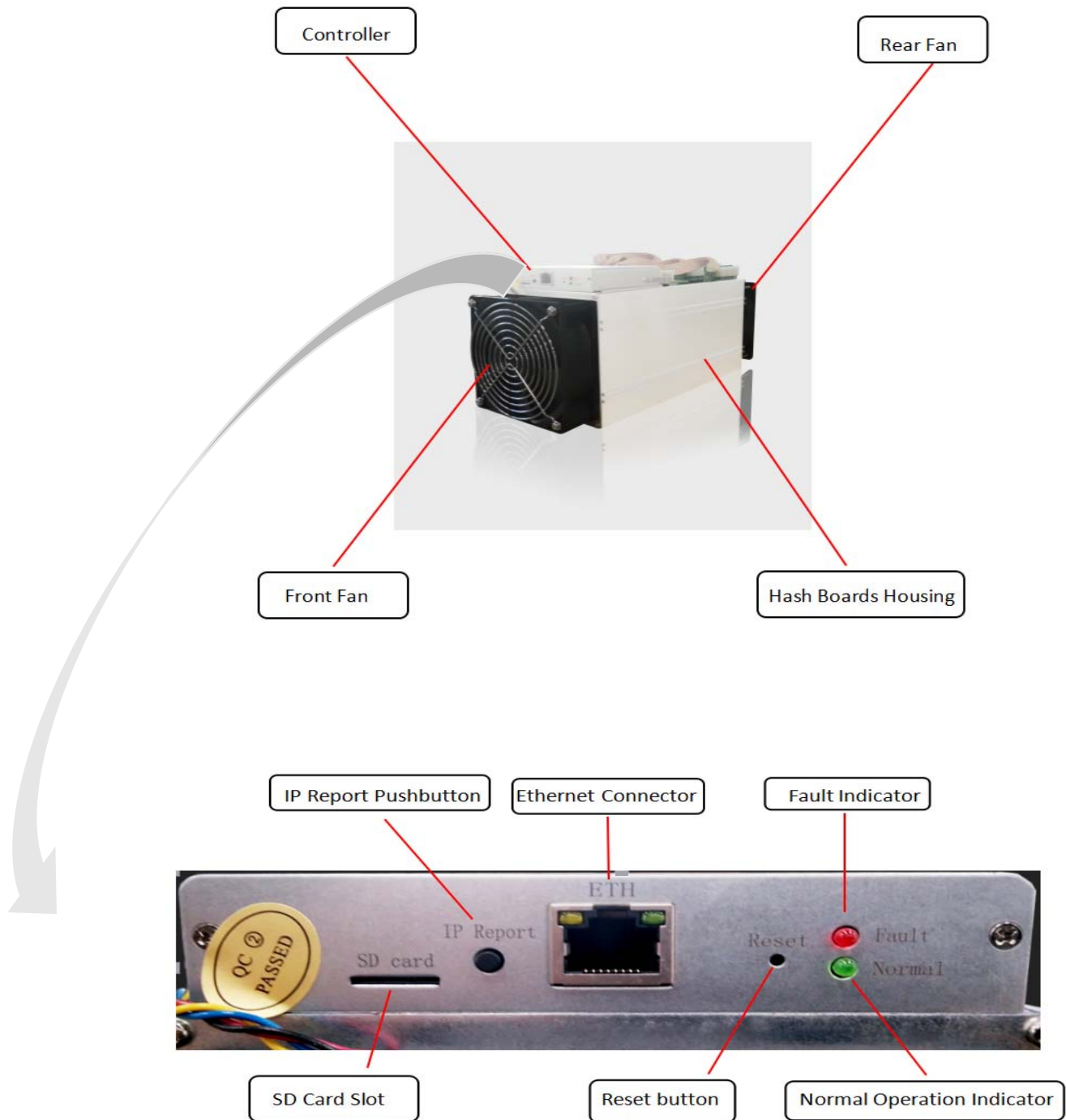

1.2 Specifications

Product Glance	Value
Product model	S9j-14.5T
Hashrate, TH/s	14.50±5%
Reference power on wall, Watt	1350±10%
Reference power efficiency on wall @25°C, J/TH	93.12±10%
Adapted AC/DC output requirement, Watt / Volt	1650 / 12.00

2. Connecting the Power Supply

Ten PCI-e connectors are located at the top of the S9j server for connecting the PSU as follows:

- Nine PCI-e connectors for the hash boards. Each hash board has three PCI-e connectors.
- One PCI-e connector located on the controller.



Each hashboard must be powered by the same PSU to prevent possible damage and instability.

To connect the power supply:

1. Connect PSU power cable connectors to each of the nine PCI-e connectors on the top of the S9j server, ensuring that each hash board is powered by the same PSU.



Controller PCI-e Power Connector

Hash Boards PCI-e Power Connector

2. Connect a PSU power cable connector to the S9j PCI-e connector on the controller.
3. Connect the network cable to the ETH port.
4. To power up your S9j server, connect the PSUs to the power wall outlet.



If you are using more than one PSU, power up the PSU connected to the controller AFTER you have Powered up the other PSU(s).

3. Setting Up the Server

To set up the server:

 The file IPReporter.zip is supported by Microsoft Windows only.

1. Go to the following site:
<https://shop.bitmain.com/support.htm?pid=00720160906053730999PVD2K0vz0693>
2. Download the following file: IPReporter.zip
3. Extract the file.

 The default DHCP network protocol distributes IP addresses automatically.

4. Right-click **IPReporter.exe** and run it as Administrator.
5. Select one of the following options:
 - Shelf, Step, Position – suitable for farm servers to mark the location of the servers.
 - Default – suitable for home servers.
6. Click **Start**.

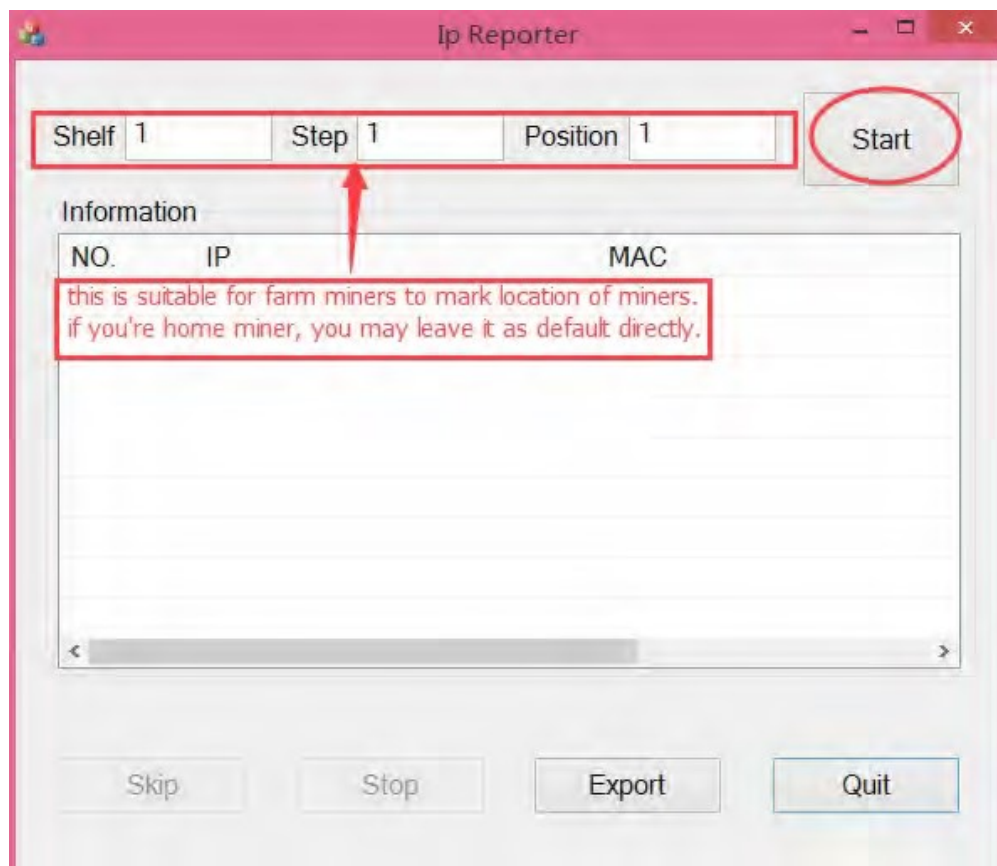

3. Setting Up the server

- On the controller board, click the IP Report button. Hold it down until it beeps (about 5 seconds).

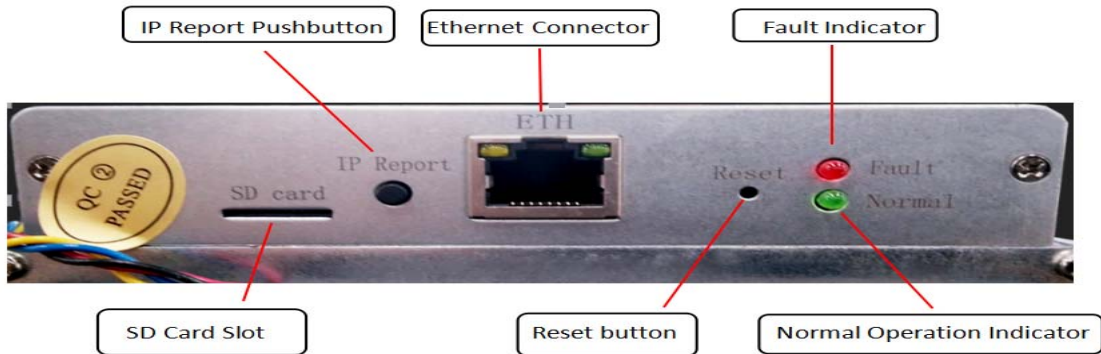

The IP address will be displayed in a window on your computer screen.

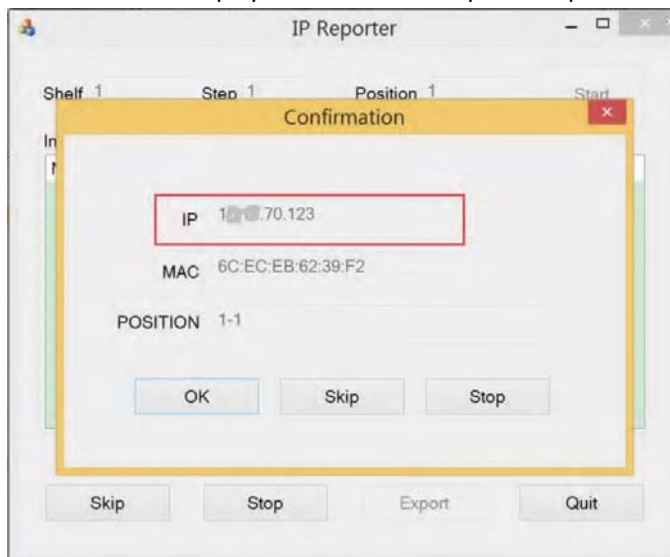

- In your web browser, enter the IP address provided.
- Proceed to login using `root` for both the username and password.
- In the Network section, you can assign a DHCP IP address (optional).
- Click **Save & Apply**.

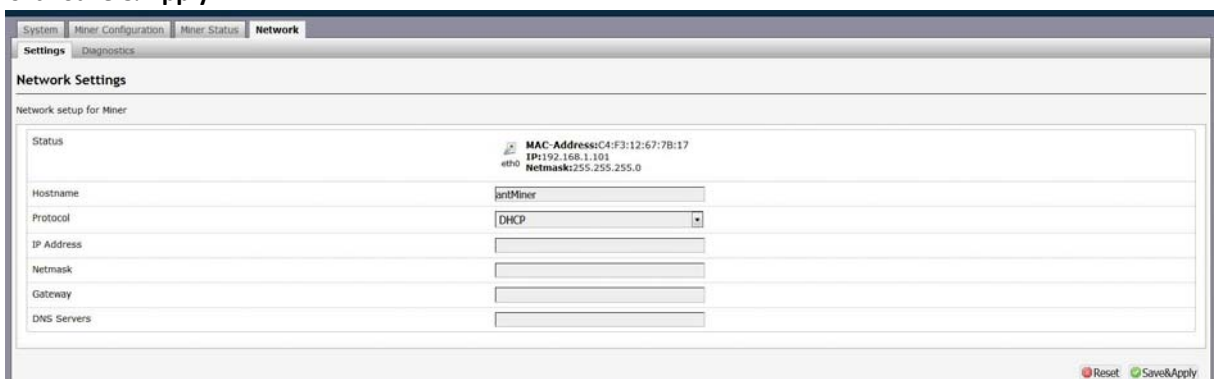

4. Configuring the Server

Setting Up the Pool

To configure the server:

1. click **General Settings**.

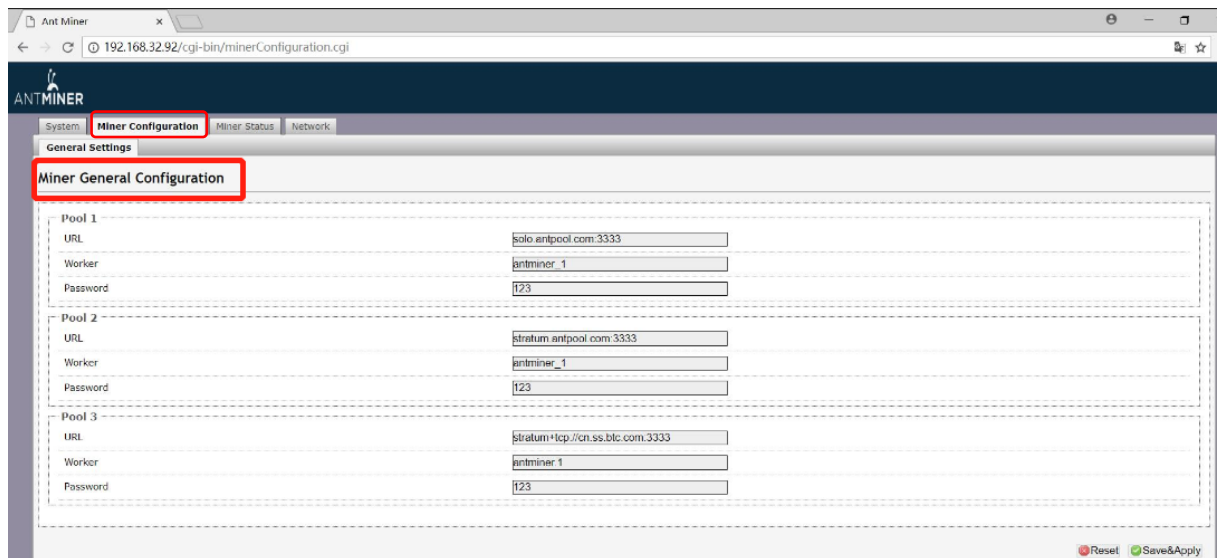

The screenshot shows the AntMiner web interface. The 'Miner Configuration' tab is selected, and the 'Miner General Configuration' section is highlighted with a red box. The configuration form contains three pools, each with fields for URL, Worker, and Password. The values are as follows:

Pool	URL	Worker	Password
Pool 1	solo.antpool.com:3333	antminer_1	123
Pool 2	stratum.antpool.com:3333	antminer_1	123
Pool 3	stratum+tcp://cn.ss.btc.com:3333	antminer_1	123

2. Set the options according to the following table:

Option	Description
Pool URL	<p>Enter the URL of your desired pool.</p> <div style="border: 1px solid black; padding: 10px; margin: 10px 0;"> <p> The S9j server can be set up with three mining pools, with decreasing priority from the first pool (pool 1) to the third pool (pool 3). The pools with low priority will only be used if all higher priority pools are offline.</p> </div>
Worker	Your worker ID on the selected pool.
Password	The password for your selected worker.

3. Click **Save & Apply** to save and restart the server.

5. Monitoring Your server

To check the operating status of your server:

1. Click the status marked below.

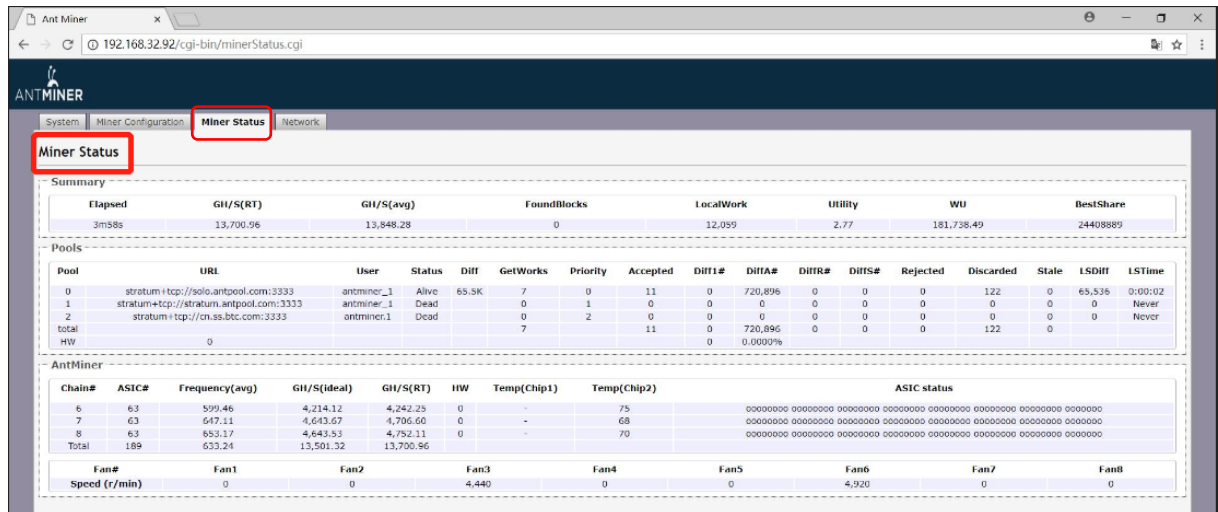

2. monitor your server according to the descriptions in the following table:

Option	Description
ASIC#	Number of chips detected in the chain.
Frequency	ASIC frequency setting.
GH/S(RT)	Hash rate of each hash board (GH/s)
Temp(PCB)	Temperature of each hash board (°C).(Applied only to server with fixed frequency)
Temp(Chip)	Temperature of the chips on each hash board (°C).
ASIC status	One of the following statuses will appear: <ul style="list-style-type: none"> ● O - indicates OK ● X - indicates error ● - - indicates dead



Note: The S9j server is with automatic frequency adjustment. Firmware will stop running when the Temp(PCB) reaches to 95 °C , there will be an error message “Fatal Error: Temperature is too high!” shown in the bottom of kernel log page.

6. Administering Your Server

6.1 Checking Your Firmware Version

To check your firmware version:

1. In **System**, click the **Overview** tab.
2. **File System Version** displays the date of the firmware your server use. In the example below, the server is using firmware version 20180713.

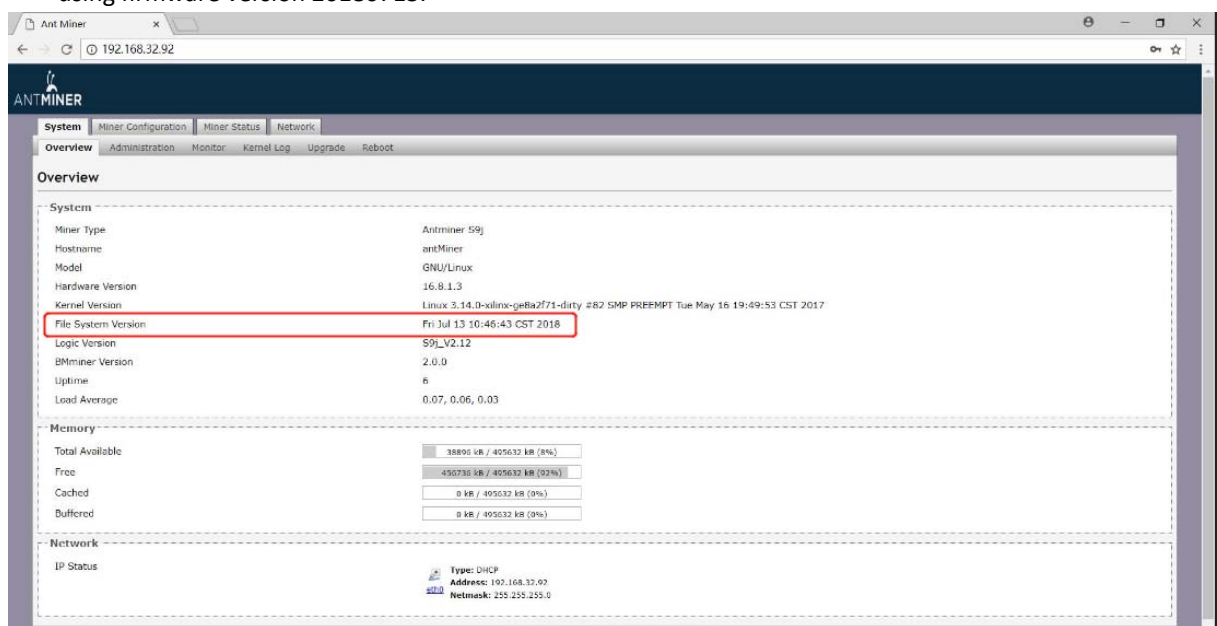

6.2 Upgrading Your System



Make sure that the S9j server remains powered during the upgrade process. If power fails before the upgrade is completed, you will need to return it to Bitmain for repair.

To upgrade the server's firmware:

1. In System, click **Upgrade**.

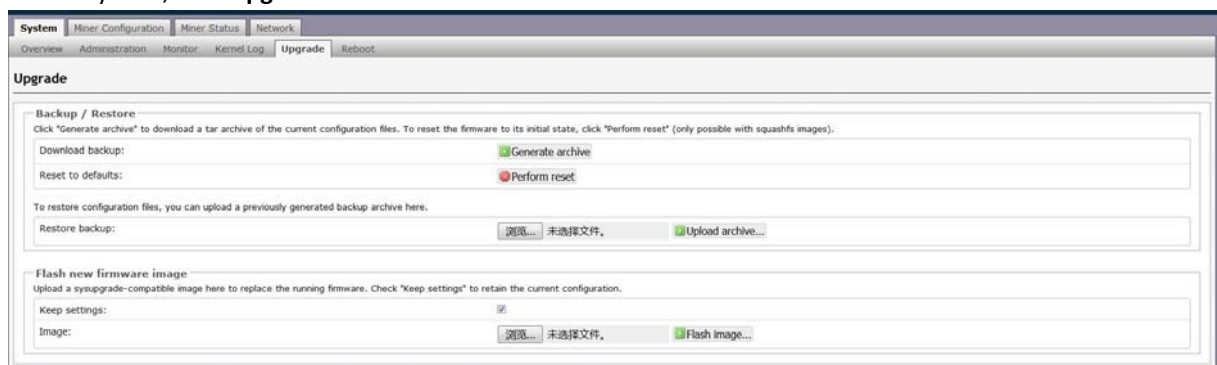

2. For **Keep Settings**:
 - Select the check box to keep your current settings (default).
 - Clear the check box to reset the server to default settings.
3. Click the **选择文件 (Browse)** button and navigate to the upgrade file. Select the upgrade file, then click **Flash image**. A message appears notifying you if the S9j firmware can be upgraded and if yes, will then proceed to flash the image.
4. When the upgrade is completed, the following message appears:

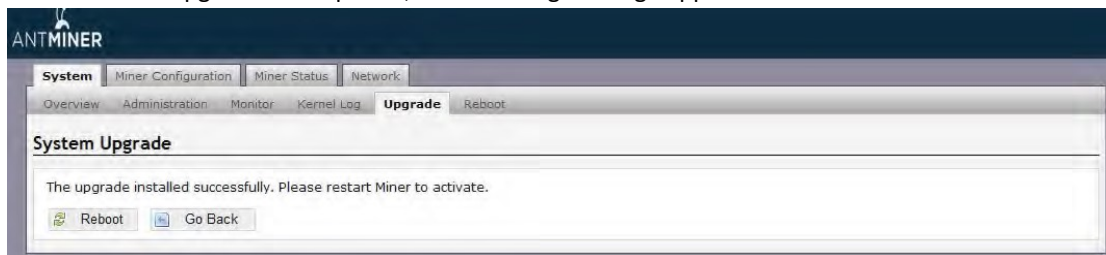

5. Click one of the following options:
 - **Reboot** - to restart the server with the new firmware.
 - **Go Back** - to continue mining with the current firmware. The server will load the new firmware next time it is restarted.

6.3 Modifying Your Password

To change your login password:

1. In **System**, click the **Administration** tab.
2. Set your new password, then click **Save & Apply**.

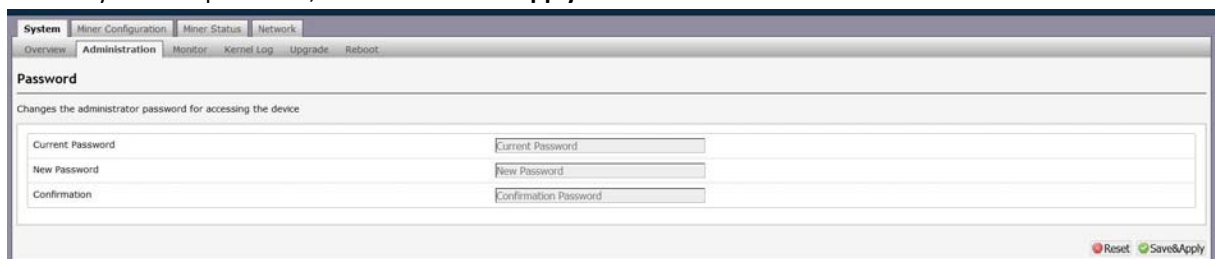

6.4 Restoring Initial Settings

To restore your initial settings

1. Turn on the server and let it run for 5 minutes.
2. On the controller front panel, press and hold the **Reset** button for 10 seconds.



Resetting your server will reboot it and restore its default settings. The red LED will automatically flash once every 15 seconds if the reset is operated successfully.

Regulation:

FCC Notice (FOR FCC CERTIFIED MODELS):

This device complies with part 15 of the FCC Rules. Operation is subject to the following two conditions: (1) This device may not cause harmful interference, and (2) this device must accept any interference received, including interference that may cause undesired operation.

Note:

This equipment has been tested and found to comply with the limits for a Class A digital device, pursuant to part 15 of the FCC Rules. These limits are designed to provide reasonable protection against harmful interference when the equipment is operated in a commercial environment. This equipment generates, uses, and can radiate radio frequency energy and, if not installed and used in accordance with the instruction manual, may cause harmful interference to radio communications. Operation of this equipment in a residential area is likely to cause harmful interference in which case the user will be required to correct the interference at his own expense.

EU WEEE: Disposal of Waste Equipment by Users in Private Household in the European Union



This symbol on the product or on its packaging indicates that this product must not be disposed of with your other household waste. Instead, it is your responsibility to dispose of your waste equipment by handing it over to a designated collection point for the recycling of waste electrical and electronic equipment. The separate collection and recycling of your waste equipment at the time of disposal will help to conserve natural resources and ensure that it is recycled in a manner that protects human health and the environment. For more information about where you can drop off your waste equipment for recycling, please contact your local city office, your household waste disposal service or the shop where you purchased the product.

台湾 ROHS:

設備名稱: _____, 型號: _____

單元	有害物質					
	鉛 (Pb)	汞 (Hg)	鎘 (Cd)	六價鉻 (Cr+6)	多溴聯苯 (PBB)	多溴二苯 醚 (PBDE)
外殼	○	○	○	○	○	○
電路板組 件	—	○	○	○	○	○
其他線材	—	○	○	○	○	○

備考 1. “超出 0.1 wt %” 及 “超出 0.01 wt %” 係指限用物質之百分比含量超出百分比含量基準

值。

備考 2. “○” 係指該項限用物質之百分比含量未超出百分比含量基準值。

備考 3. “—” 係指該項限用物質為排除項目