



S9i Server Installation Guide

Document Version 0.1

Nov 2019

© Copyright Bitmain Technologies Holding Company 2007 – 2022. All rights reserved. Bitmain Cayman (hereinafter referred to as 'Bitmain') reserves the right to make corrections, modifications, enhancements, improvements, and other changes to its products and services at any time and to discontinue any product or service without notice. Customers should obtain the latest relevant information before placing orders and should verify that such information is current and complete. All products are sold subject to Bitmain's terms and conditions of sale supplied at the time of order acknowledgment.

Bitmain warrants performance of its products to the specifications applicable at the time of sale in accordance with Bitmain's standard warranty. Testing and other quality control techniques are used to the extent Bitmain deems necessary to support this warranty. Except where mandated by government requirements, testing of all parameters of each product is not necessarily performed.

Bitmain assumes no liability for third-party applications assistance. Customers are responsible for their products and applications using Bitmain components. To minimize the risks associated with customer products and applications, customers should provide adequate design and operating safeguards.

Bitmain does not warrant or represent that any license, either express or implied, is granted under any Bitmain patent right, copyright or other Bitmain intellectual property right relating to any combination, machine, or process in which Bitmain products or services are used. Information published by Bitmain regarding third-party products or services does not constitute a license from Bitmain to use such products or services or a warranty or endorsement thereof. Use of such information may require a license from a third party under the patents or other intellectual property of the third party, or a license from Bitmain under the patents or other intellectual property of Bitmain.

Resale of Bitmain products or services with statements different from or beyond the parameters stated by Bitmain for that product or service voids all express and any implied warranties for the associated Bitmain product or service and is an unfair and deceptive business practice. Bitmain is not responsible or liable for any such statements.

All company and brand products and service names are trademarks or registered trademarks of their respective holders.

All text and figures included in this publication are the exclusive property of Bitmain, and may not be copied, reproduced, or used in any way without the express written permission of Bitmain. Information in this document is subject to change without notice and does not represent a commitment on the part of Bitmain. Although the information in this document has been carefully reviewed, Bitmain does not warrant it to be free of errors or omissions. Bitmain reserves the right to make corrections, updates, revisions or changes to the information in this document.

Bitmain

Tel:+86-400-890-8855

www.bitmain.com

Table of Contents

1. Overview	4
1.1 S9i Server Components.....	5
1.2 Specifications.....	6
2. Connecting to the Power Supply	7
3. Setting Up the Server	8
4. Configuring the Server	10
5. Monitoring Your Server.....	11
6. Administering Your Server	12
6.1 Checking Your Firmware Version.....	12
6.2 Upgrading Your System	12
6.3 Modifying Your Password	13
6.4 Restoring Initial Settings.....	13
Environmental Requirements	14
Regulations.....	16

1. Overview

The S9i server is one of the products in Bitmain's S9 miner series. All S9i servers are tested and configured prior to shipping to ensure easy set up.

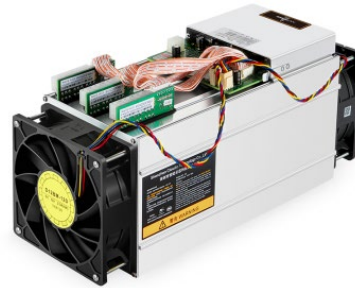

You must provide your own ATX power supply.

1.1 S9i Server Components

The S9i server main components and controller front panel are shown in the following figure:

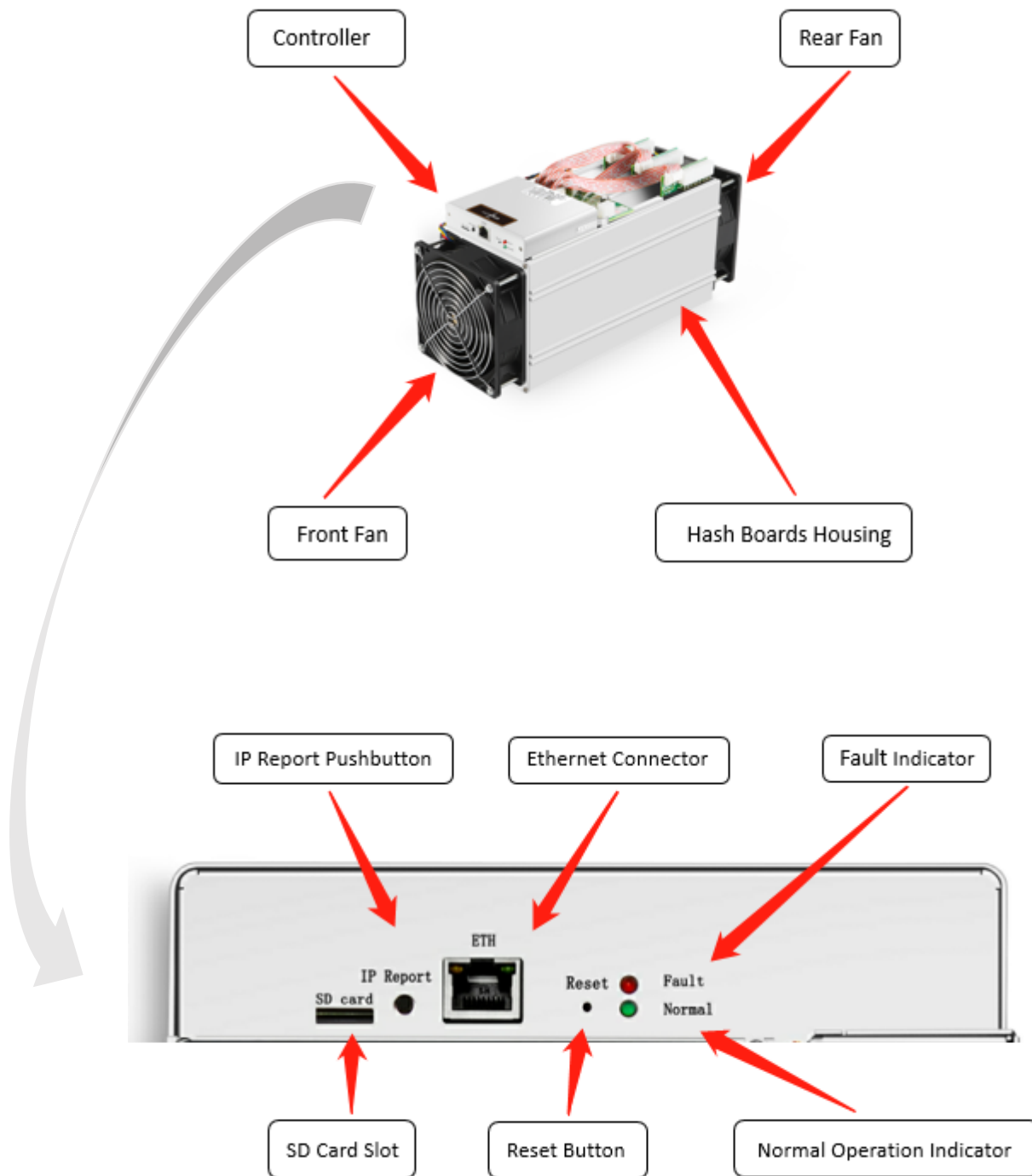

1.2 Specifications

Hash Rate	S9i-13 TH/s, 13.5 TH/s, 14 TH/s, 14.5 TH/s
Power Consumption	1290 W (13 TH/s) 1310 W (13.5 TH/s) 1320 W (14 TH/s) 1365 W(14.5 TH/s)
Power Efficiency	99 J/TH (13 TH/s) 97 J/TH (13.5 TH/s) 94 J/TH (14 TH/s) 94.14 J/TH (14.5 TH/s)
Rated Voltage	11.60 ~13.00 V
Frequency	Auto-frequency
Network connection mode	Ethernet
Operating temperature	0 - 40 °C
Storage temperature	-40 - 85°C
Operating humidity	5%RH-95%RH, No condensation
Product weight (without package)	4.2 kg
Product dimensions	350mm(L) x 135mm(W) x 158mm(H)

2. Connecting to the Power Supply

Ten PCI-e connectors are located at the top of the S9i server for connecting the PSU as follows:

- Nine PCI-e connectors for the hash boards. Each hash board has three PCI-e connectors.
- One PCI-e connector located on the controller.



Each hashboard must be powered by the same PSU to prevent possible damage and instability.

To connect the power supply:

1. Connect PSU power cable connectors to each of the nine PCI-e connectors on the top of the S9i server, ensuring that each hash board is powered by the same PSU.

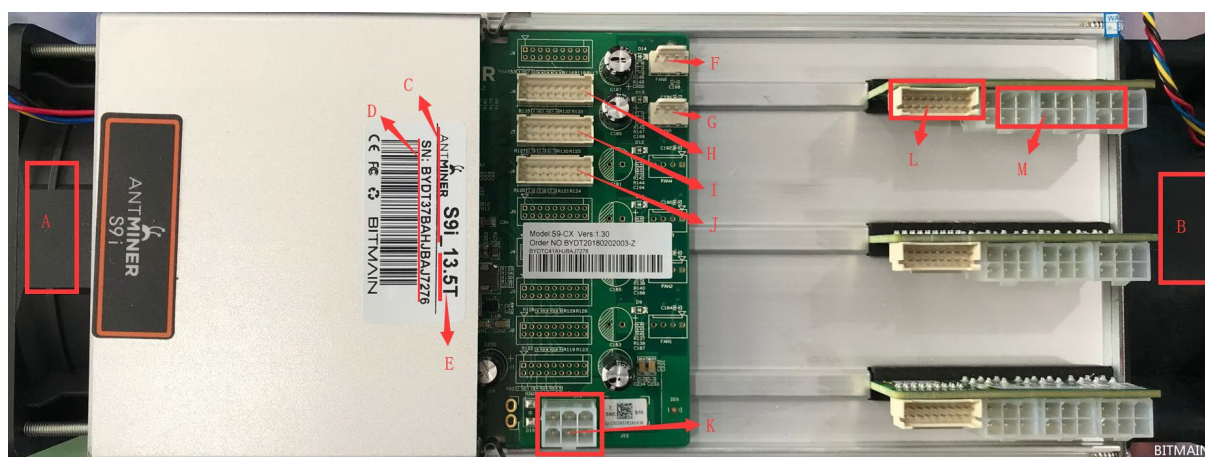

A. Front fan (intake fans); B. Rear fan (exhaust fans); C. Miner model; D. Serial number (SN) of miner, to review warranty status; E. Estimated hash rate of miner model; F. Rear fan connector; G. Front fan connector; H. Chain #8 connector; I. Chain #7 connector; J. Chain #6 connector; K. 6-pin power connector; L. Control board chain connector; M. 6-pin power connector

2. Connect a PSU power cable connector to the S9i PCI-e connector on the controller.
3. Connect the network cable to the ETH port.
4. To power up your S9i server, connect the PSUs to the power wall outlet.



If you are using more than one PSU, power up the PSU connected to the controller AFTER you have Powered up the other PSU(s).

3. Setting Up the Server

To set up the server:

 The file IPReporter.zip is supported by Microsoft Windows only.

1. Go to the following site:
<https://shop.bitmain.com/support.htm?pid=00720160906053730999PVD2K0vz0693>
2. Download the following file: IPReporter.zip
3. Extract the file.

 The default DHCP network protocol distributes IP addresses automatically.

4. Right-click **IPReporter.exe** and run it as Administrator.
5. Select one of the following options:
 - Shelf, Step, Position – suitable for farm servers to mark the location of the servers.
 - Default – suitable for home servers.
6. Click **Start**.

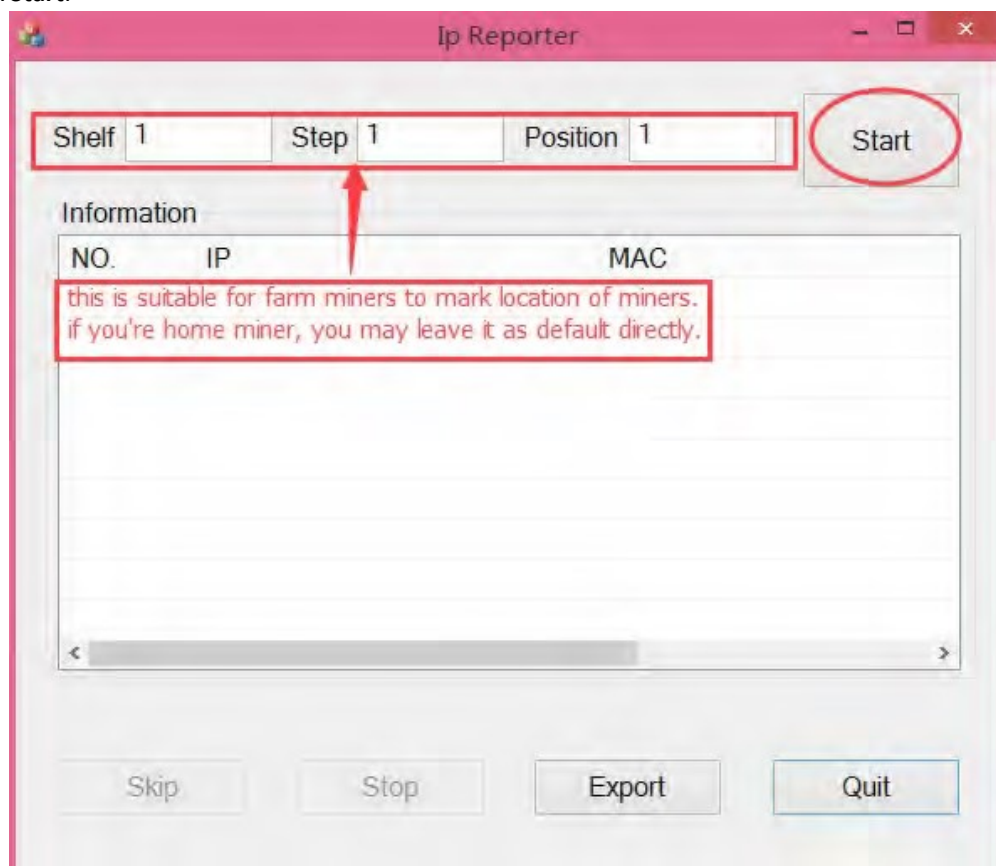

3. Setting Up the server

- On the controller board, click the IP Report button. Hold it down until it beeps (about 5 seconds).

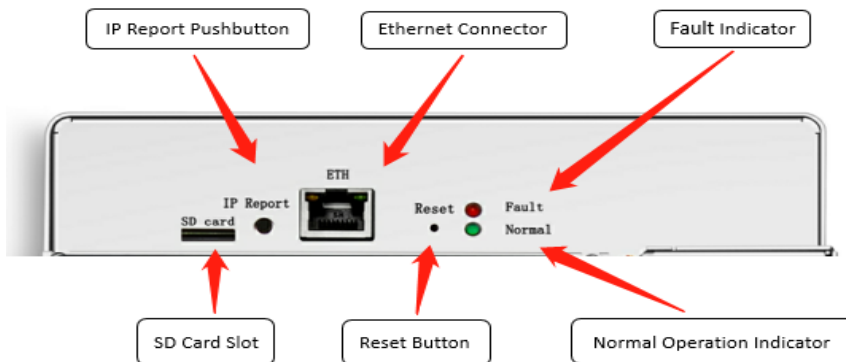

The IP address will be displayed in a window on your computer screen.

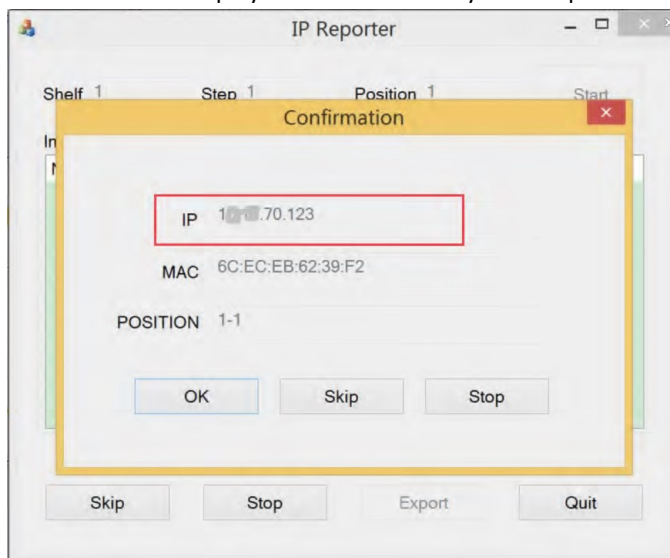

- In your web browser, enter the IP address provided.
- Proceed to login using `root` for both the username and password.
- In the Network section, you can assign a DHCP IP address (optional).
- Click **Save & Apply**.

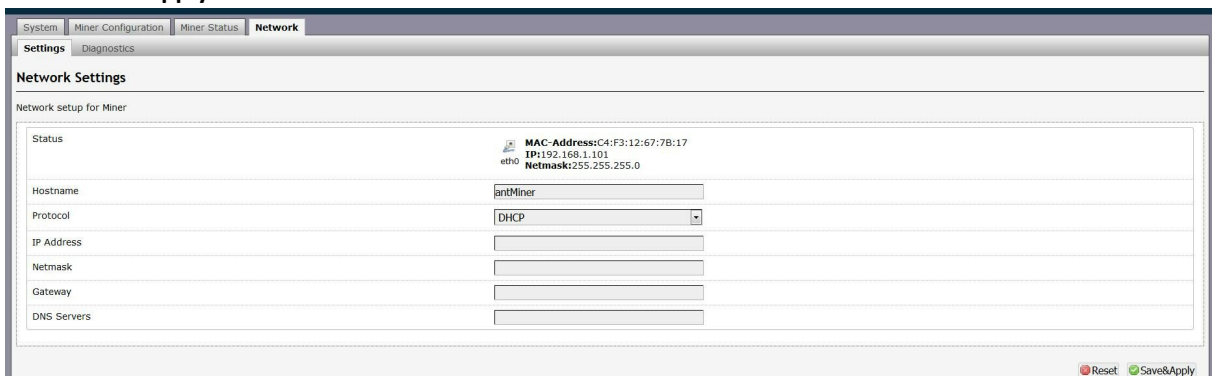

4. Configuring the Server

Setting Up the Pool

To configure the server:

1. click **General Settings**. (Here takes S9i-14T running under the firmware with “Normal” mode as an example)

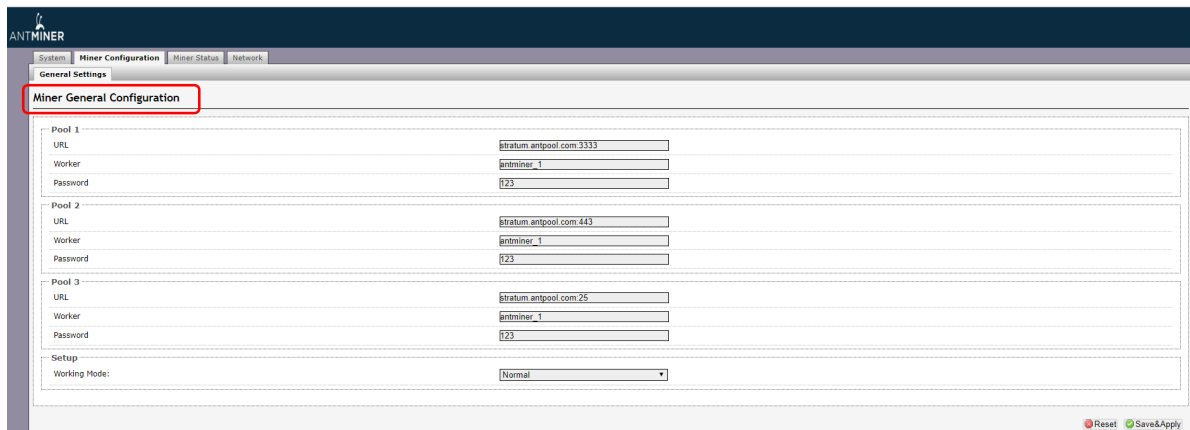

2. Set the options according to the following table:

Option	Description
Pool URL	<p>Enter the URL of your desired pool.</p> <div style="border: 1px solid black; padding: 10px; margin: 10px 0;">  <p>The S9i server can be set up with three mining pools, with decreasing priority from the first pool (pool 1) to the third pool (pool 3). The pools with low priority will only be used if all higher priority pools are offline.</p> </div>
Worker	Your worker ID on the selected pool.
Password	The password for your selected worker.

3. Click **Save & Apply** to save and restart the server.

5. Monitoring Your server

To check the operating status of your server:

1. Click the status marked below. (Here takes S9i-14T running under the firmware with “Normal” mode as an example)

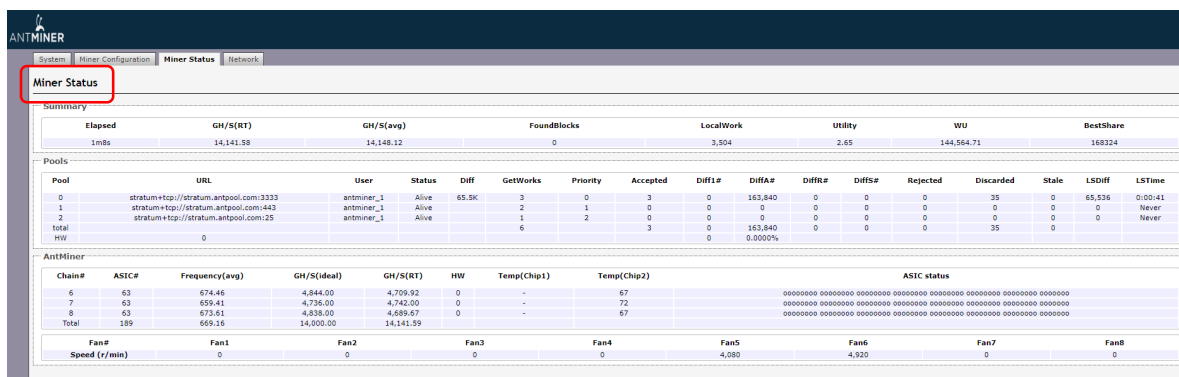

The screenshot shows the ANTMINER web interface. The 'Miner Status' tab is selected and highlighted with a red box. The interface displays several sections:

- Summary:** A table showing overall mining statistics: Elapsed (1m5s), GH/S(RT) (14,141.58), GH/S(avg) (14,146.12), FoundBlocks (0), LocalWork (3,504), Utility (2.65), WU (144,564.71), and BestShare (169324).
- Pools:** A table listing mining pools with columns for Pool, URL, User, Status, Diff, GetWorks, Priority, Accepted, Diff1#, DiffA#, DiffR#, DiffS#, Rejected, Discarded, Stale, LSDiff, and LSTime.
- AntiMiner:** A table showing ASIC chip details with columns for Chain#, ASIC#, Frequency(avg), GH/S(ideal), GH/S(RT), HW, Temp(Chip1), Temp(Chip2), and ASIC status.
- Fan #:** A table showing fan speeds for Fan1 through Fan8 in r/min.

2. monitor your server according to the descriptions in the following table:

Option	Description
ASIC#	Number of chips detected in the chain.
Frequency	ASIC frequency setting.
GH/S(RT)	Hash rate of each hash board (GH/s)
Temp(PCB)	Temperature of each hash board (°C).(Applied only to server with fixed frequency)
Temp(Chip)	Temperature of the chips on each hash board (°C).
ASIC status	One of the following statuses will appear: <ul style="list-style-type: none"> ● O - indicates OK ● X - indicates error ● - - indicates dead



Note: The S9i server is with automatic frequency. Firmware will stop running when the Temp (PCB) reaches to 90°C, there will be an error message “Fatal Error: Temperature is too high!” shown in the bottom of kernel log page.

6. Administering Your Server

6.1 Checking Your Firmware Version

To check your firmware version:

1. In **System**, click the **Overview** tab.
2. **File System Version** displays the date of the firmware your server use. In the example below, the server is using firmware version 20190730.

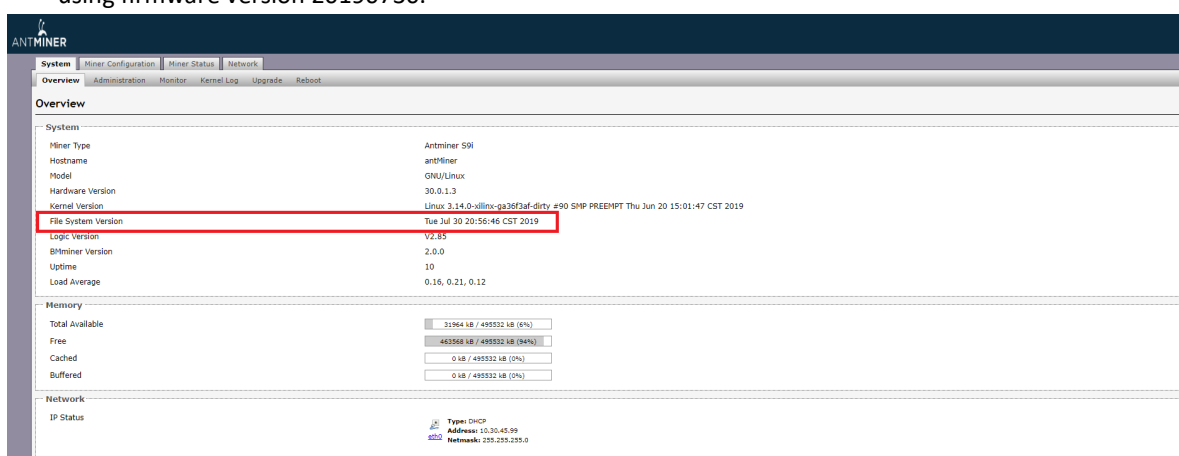

6.2 Upgrading Your System



Make sure that the S9i server remains powered during the upgrade process. If power fails before the upgrade is completed, you will need to return it to Bitmain for repair.

To upgrade the server's firmware:

1. In **System**, click **Upgrade**.

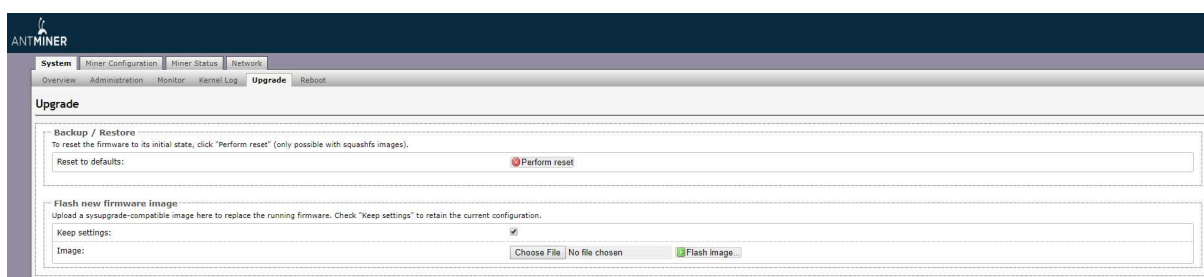

2. For **Keep Settings**:
 - Select the check box to keep your current settings (default).
 - Clear the check box to reset the server to default settings.
3. Click the **选择文件 (Browse)** button and navigate to the upgrade file. Select the upgrade file, then click **Flash image**. A message appears notifying you if the S9i firmware can be upgraded and if yes, will then proceed to flash the image.
4. When the upgrade is completed, the following message appears:

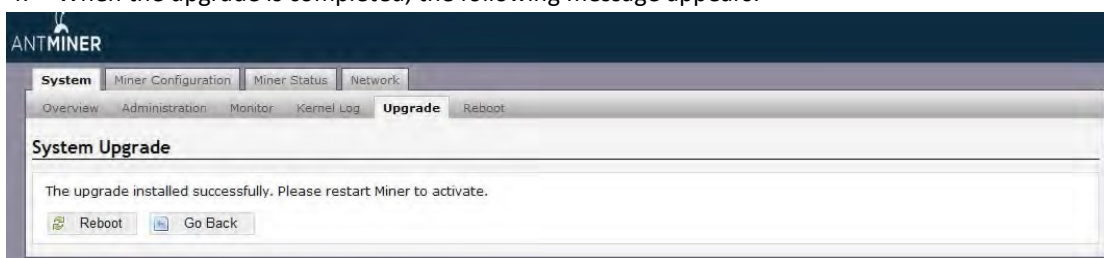

5. Click one of the following options:
 - **Reboot** - to restart the server with the new firmware.
 - **Go Back** - to continue mining with the current firmware. The server will load the new firmware next time it is restarted.

6.3 Modifying Your Password

To change your login password:

1. In **System**, click the **Administration** tab.
2. Set your new password, then click **Save & Apply**.

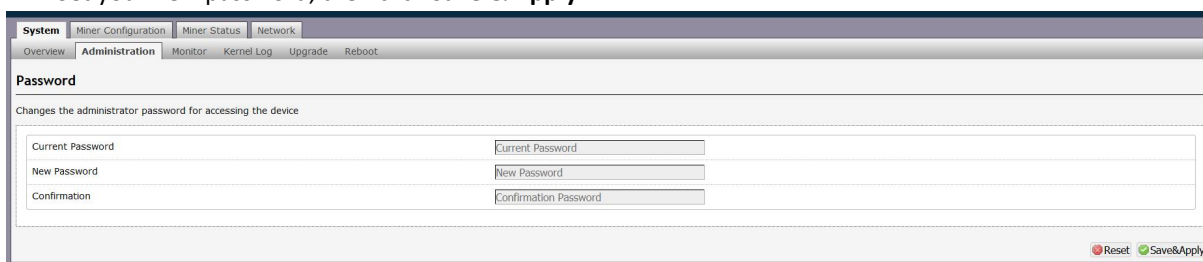

6.4 Restoring Initial Settings

To restore your initial settings

1. Turn on the server and let it run for 5 minutes.
2. On the controller front panel, press and hold the **Reset** button for 10 seconds.



Resetting your server will reboot it and restore its default settings. The red LED will automatically flash once every 15 seconds if the reset is operated successfully.

Environmental Requirements

Please run your server in accordance with the following requirements

1. Basic Environmental Requirements:

1.1. Climatic Conditions:

Description	Requirement
Operating Temperature	0-40°C
Operating Humidity	10-90%RH (non-condensing)
Storage Temperature	-20-70°C
Storage Humidity	5-95%RH (non-condensing)
Altitude	<2000m

1.2. Site Requirements of the Server Running Room:

Please keep the server running room away from industrial pollution sources:

For heavy pollution sources such as smelters and coal mines, the distance should be more than 5km.

For moderate pollution sources such as chemical industries, rubber and electroplating industries, the distance should be more than 3.7km.

For light pollution sources such as food factories and leather processing factories, the distance should be more than 2km.

If unavoidable, the site should be chosen in the perennial upwind direction of the pollution source.

Please do not set your location within 3.7km from the seaside or the salt lake. If unavoidable, it should be built as airtight as possible, equipped with air conditioning for cooling.

1.3. Electromagnetic Environmental Conditions:

Please keep your site away from transformers, high-voltage cables, transmission lines and high-current equipment, for example, there should be no high-power AC transformers (>10KA) within 20 meters, and no high-voltage power lines within 50 meters.

Please keep your site away from high-power radio transmitters, for example, there should be no high-power radio transmitters (>1500W) within 100 meters.

2. Other Environmental Requirements :

The server running room shall be free of explosive, conductive, magnetically conductive and corrosive dust. The requirements of mechanical active substances are shown below:

2.1 Requirements of Mechanical Active Substances

Mechanical Active Substance	Requirement
Sand	$\leq 30\text{mg}/\text{m}^3$
Dust (suspended)	$\leq 0.2\text{mg}/\text{m}^3$
Dust (deposited)	$\leq 1.5\text{mg}/\text{m}^2\text{h}$

2.2 Requirements of Corrosive Gas

Corrosive Gas	Unit	Concentration
H ₂ S	ppb	< 3
SO ₂	ppb	< 10
Cl ₂	ppb	< 1
NO ₂	ppb	< 50
HF	ppb	< 1
NH ₃	ppb	< 500
O ₃	ppb	< 2

Note: ppb (part per billion) refers to the unit of concentration, 1ppb stands for the volume ratio of part per billion.

Regulation:

FCC Notice (FOR FCC CERTIFIED MODELS):

This device complies with part 15 of the FCC Rules. Operation is subject to the following two conditions: (1) This device may not cause harmful interference, and (2) this device must accept any interference received, including interference that may cause undesired operation.

Note:

This equipment has been tested and found to comply with the limits for a Class A digital device, pursuant to part 15 of the FCC Rules. These limits are designed to provide reasonable protection against harmful interference when the equipment is operated in a commercial environment. This equipment generates, uses, and can radiate radio frequency energy and, if not installed and used in accordance with the instruction manual, may cause harmful interference to radio communications. Operation of this equipment in a residential area is likely to cause harmful interference in which case the user will be required to correct the interference at his own expense.

EU WEEE: Disposal of Waste Equipment by Users in Private Household in the European Union



This symbol on the product or on its packaging indicates that this product must not be disposed of with your other household waste. Instead, it is your responsibility to dispose of your waste equipment by handing it over to a designated collection point for the recycling of waste electrical and electronic equipment. The separate collection and recycling of your waste equipment at the time of disposal will help to conserve natural resources and ensure that it is recycled in a manner that protects human health and the environment. For more information about where you can drop off your waste equipment for recycling, please contact your local city office, your household waste disposal service or the shop where you purchased the product.

台灣 ROHS:

設備名稱： S9i 服务器

單元	有害物質					
	鉛 (Pb)	汞 (Hg)	鎘 (Cd)	六價鉻 (Cr+6)	多溴聯苯 (PBB)	多溴二苯醚 (PBDE)
外殼	○	○	○	○	○	○
電路板組件	—	○	○	○	○	○
其他線材	—	○	○	○	○	○

備考 1. “超出 0.1 wt %” 及 “超出 0.01 wt %” 係指限用物質之百分比含量超出百分比含量基準值。
 備考 2. “○” 係指該項限用物質之百分比含量未超出百分比含量基準值。
 備考 3. “—” 係指該項限用物質為排除項目